



A New Sub-Terahertz Testbed for 6G Research

The first 5G networks are commercial and expanding. We are on the cusp of realizing the next generation of high-speed, high-reliability, and flexible mobile connectivity. This connectivity is driving advanced new consumer applications as the second generation of commercial 5G user equipment arrives on the market. It also opens up new possibilities in developing smart factories and smart cities and in meeting challenges in sectors as diverse as agriculture, public health, and global resource management.

The pace of innovation continues to accelerate. Even with 5G in its early stages of expansion, research has begun for 6G. Keysight has joined the multiparty 6G Flagship Program. As a founding member, Keysight will participate in groundbreaking 6G research that pushes the boundaries of high-speed, high-bandwidth communications. The vision for 6G includes concepts such as holographic communications and time-engineered systems that take the next step beyond the benefits of 5G — thus expanding into even more sectors that depend upon always-on connectivity.

6G research is in its very early stages. The vision for what the International Telecommunication Union calls Network 2030 is still taking shape. We are years away from even starting the standards development process. 6G is thus mostly speculative. Early thinking has 6G targets like individual data rates of 100 gigabits per second (Gb/s) ^[1] and perhaps up to 1 terabit per second (Tb/s) ^[2]. That is more than 100 times faster than 5G, with ultra-low latency as well as very high precision in information timing ^[3]. Like 5G, 6G is by no means exclusive to higher frequencies and bandwidths. But sub-terahertz territory is part of the active research, and achieving this performance involves extreme modulation bandwidths in the sub-terahertz (100–300 GHz) or terahertz (300 GHz – 3 THz) spectrum. Getting there will require significant advances in materials, computing architectures, and chip designs.

These technical advances will require a flexible and scalable testbed to enable researchers to gain insight into the performance of their designs while 6G evolves. This white paper introduces a new sub-terahertz testbed for D-band (110–170 GHz) and G-band (140–220 GHz). Waveform flexibility is enabled using software and programmable baseband hardware to generate and analyze candidate waveforms. The testbed hardware is also multichannel so that researchers can scale the number of channels for multiple-input / multiple-output (MIMO) research.

Error vector magnitude (EVM) performance will be a critical metric for 6G hardware to achieve high data throughput using higher-order modulation formats. If the residual EVM of the test system is too high, it can mask the true performance of a device under test (DUT). The test system residual EVM performance needs to be low enough that researchers can gain insight into their DUT performance.

The sub-terahertz frequency range presents many unknowns. One of those unknowns is exploring the level of system performance that is achievable and reasonable given new frequency bands, extreme modulation bandwidths, and new waveforms. This white paper provides insight into this by demonstrating EVM measurement results at 140 GHz with varying waveforms and bandwidths up to an occupied bandwidth of 10 GHz.

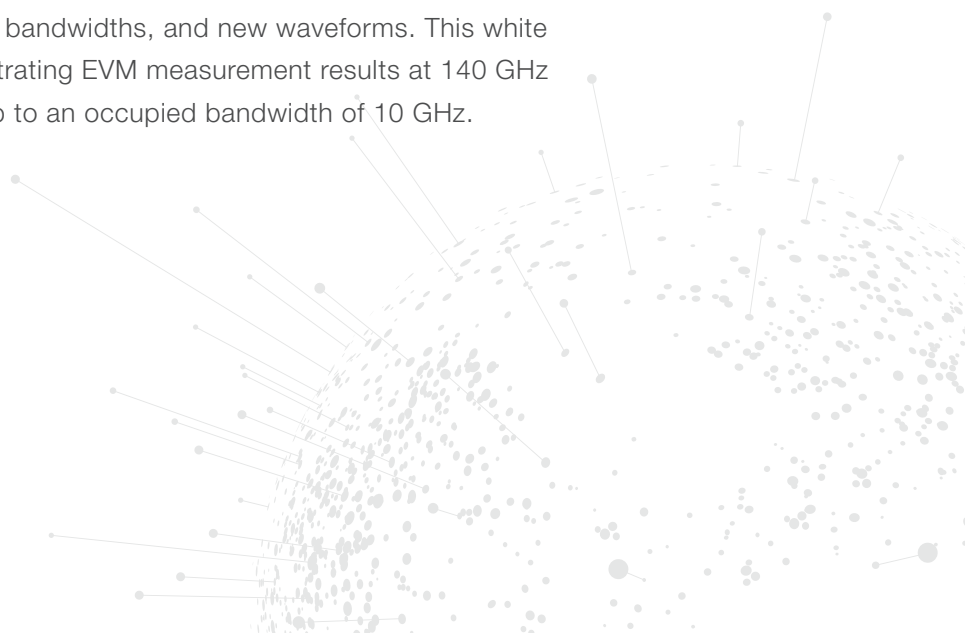

High-Band Millimeter-Wave Spectrum

The United States, through the Federal Communications Commission's (FCC) Spectrum Horizons First Report and Order, is taking a leadership role in the future of 5G and beyond. It is making available more spectrum as a result of this initiative. As part of this work, the FCC approved 21.1 GHz of new unlicensed spectrum between 95 GHz and 3 THz for use by devices that do not interfere with existing governmental and scientific operations and that operate within a maximum threshold, as stated in the order.

Figure 1 shows these unlicensed blocks of spectrum (116–123 GHz, 174.8–182 GHz, 185–190 GHz, and 244–246 GHz) in the light purple blocks. [4]

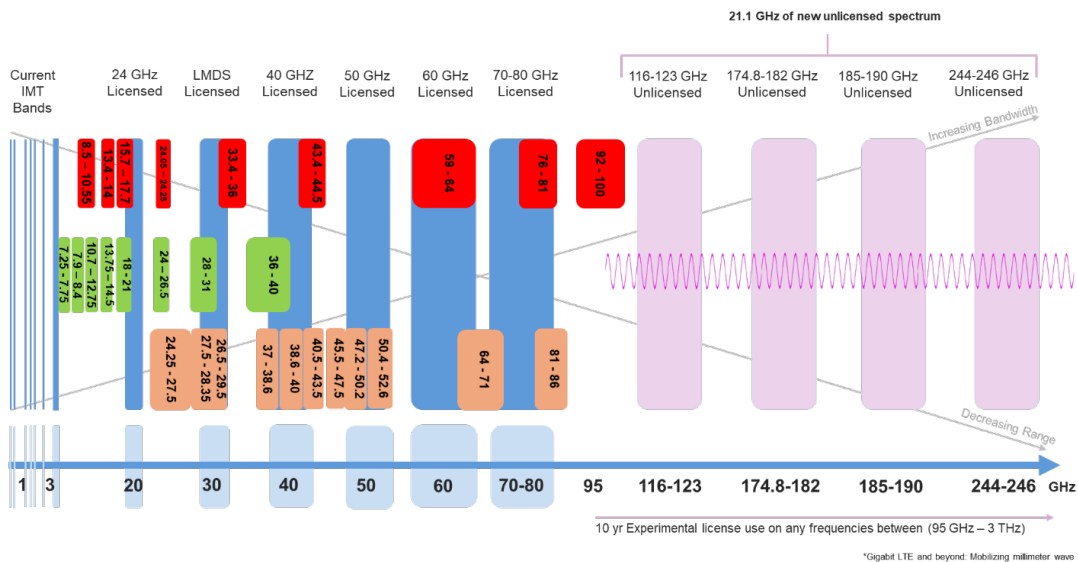

Figure 1. 10-year experimental licensed spectrum between 95 GHz and 3 THz in the United States

FCC Spectrum Horizons gives researchers, innovators, and entrepreneurs the flexibility to conduct experiments outside the unlicensed blocks between 95 GHz and 3 THz through experimental licenses lasting up to 10 years. They may also more easily market and demo equipment during the trial period. This will encourage the development of communication technologies and services above 95 GHz, such as data-intensive high-bandwidth applications; wireless cognition; and imaging, positioning, and sensing operations. [4]

National and international spectrum policy will continue to evolve for 5G and beyond. This evolution will have implications for which frequency bands will be relevant for 6G product development, but advanced research has begun in frequency bands that may evolve to be candidates for 6G.

Signal transmission in these upper millimeter-wave (mmWave) bands can incur significant propagation loss, particularly at several frequencies where there are absorption peaks. The spectral regions between absorption peaks provide potential signal transmission windows at about 94 GHz, 140 GHz, and 220 GHz ^[5]. This white paper focuses on D-band (110–170 GHz), where there is approximately 60 GHz of spectrum that ultra-wide bandwidth applications could use ^[6]. Channel sounding and propagation measurements have begun at 140 GHz within the D-band (110–170 GHz) for various building materials, comparing them to measurements performed at 28 GHz and 73 GHz ^[6].

Exploring new spectrum characteristics will also require channel sounding in other potential frequency bands. System-level simulations can then help evaluate system performance under a variety of scenarios to help system engineers gain insight into design requirements.

Design and Test Challenges

New regions of spectrum offer the potential of using these frequency bands for breakthrough high-data-throughput applications. However, there are four key considerations for optimizing the performance of sub-terahertz systems operating over wide or extreme bandwidths:

- optimizing signal-to-noise ratio (SNR)
- minimizing phase noise
- addressing linear and nonlinear impairments
- making a waveform selection

Optimizing SNR is an important consideration to achieve the best EVM performance:

- Consider the “S”: On one hand, maximizing signal power achieves the highest SNR. On the other hand, reducing the signal power is necessary to avoid compressing any components along the signal chain, given the statistical peak-to-average signal characteristics of complex waveforms.
- Consider the “N”: The noise contributions for SNR can be problematic for wideband applications because the noise power is integrated over wide signal bandwidths. For example, a 6G 10 GHz bandwidth signal would have 1,000 times more integrated noise than a 10 MHz LTE signal (or 30 dB).
- Consider the “R”: The SNR is effectively “squeezed” both on the high end and the low end. This is a key consideration in moving to extreme bandwidth test systems, and the SNR can often translate into what residual EVM is achievable.

Upconversion from an intermediate frequency (IF) to sub-terahertz frequencies involves frequency translation with a local oscillator (LO) signal source(s) and frequency converter(s). The same is true for downconversion from sub-terahertz frequencies to an intermediate frequency. Any frequency multipliers present are most often used only in the LO path rather than the signal path to avoid impacting the signal modulation characteristics. A frequency multiplier will increase the phase noise by $20 \cdot \log(N)$, where N is the multiplication factor. Furthermore, the multiplier can introduce additive phase noise that will further degrade the multiplied LO phase noise, dependent on the quality of the multiplier used. Low residual EVM test system performance at sub-terahertz frequencies requires high-quality, low-phase-noise LO signal sources.

To illustrate this, Keysight's PathWave System Design (SystemVue) simulates the effects of LO phase noise on a hypothetical sub-terahertz upconverter design. (This is only for illustration purposes to highlight key considerations and is not meant to model an actual design.)

The simulation case study uses a simple upconverter design with a modulation IF source set to a center frequency of 6 GHz. The modulation order can be set to QPSK, 16 QAM, or 64 QAM and the symbol rate set to 8.8 GHz with a root-raised cosine filter alpha of 0.22.

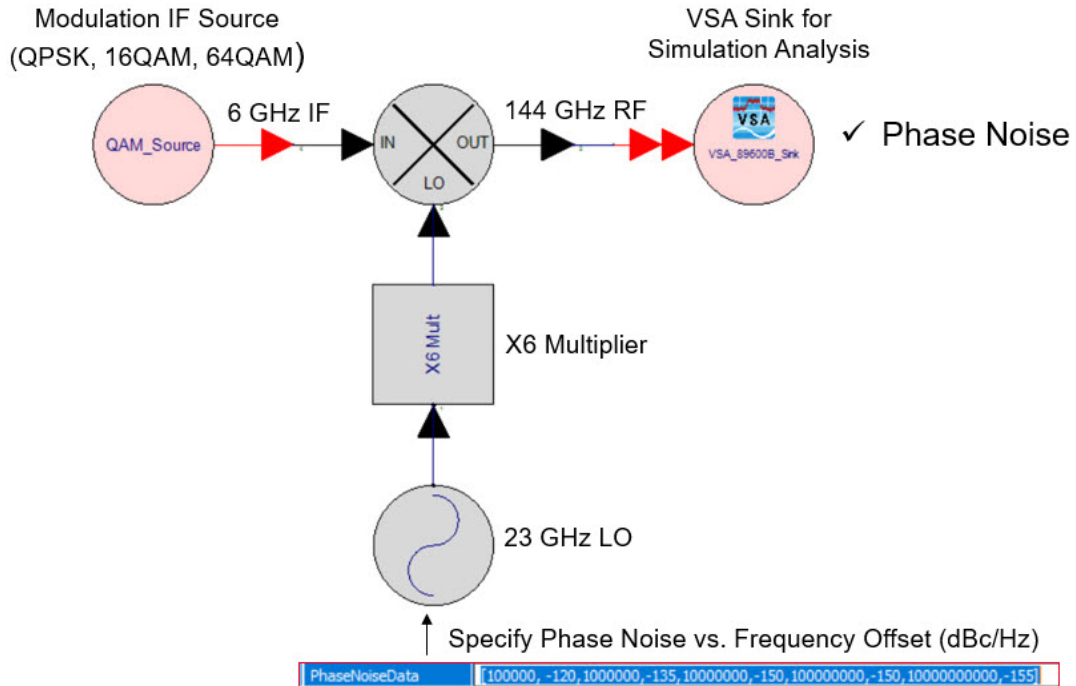

Figure 2. Phase noise for sub-terahertz upconverter design

The modulated IF is upconverted to 144 GHz using a mixer with a low-side LO. The LO source frequency is set to 23 GHz, followed by a 6x multiplier, so the mixer LO frequency is 138 GHz; 138 GHz plus the 6 GHz IF yields an upconverted frequency of 144 GHz. A nonlinear hardware mixer would also produce an image at the LO frequency minus the IF, or 132 GHz, along with other spurious products that would require filtering. We will discuss this next.

LO phase noise is specified in terms of dBc/Hz at different frequency offsets, so the phase noise is modeled with frequency offsets greater than 100 kHz. For this first simulation scenario, the phase noise parameters are set for a profile that is easy to modify to evaluate the phase noise requirements.

A vector signal analysis (VSA) sink sits at the upconverter output. This VSA sink will use the PathWave 89600 VSA software to post-process and analyze the simulation results. This same PathWave 89600 VSA software works with Keysight signal analyzers, oscilloscopes, and digitizers to perform hardware measurements, but in this scenario it is used to analyze the simulation results.

The simulation results for this first scenario are on the left in Figure 3. On the lower left, we see the signal centered at 144 GHz, with approximately 10 GHz of occupied bandwidth. On the upper left, we see the 16 QAM constellation. If we zoom in on one of the constellation states (circled in white), we see some minimal dispersion as a result of the LO phase noise. This minimal dispersion of the constellation states corresponds to the 1.56% EVM shown on the summary.

✓ Phase Noise

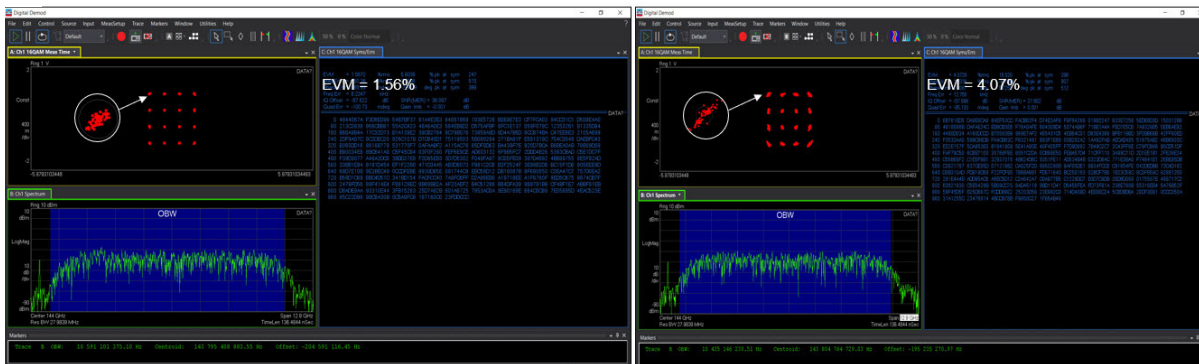

Simulated Using dBc/Hz from Phase Noise Profile in Previous Slide

Increased Phase Noise by 10 dBc/Hz for Higher Frequency Offsets

Figure 3. Phase noise simulation results

A second scenario, shown on the right, increases the phase noise by 10 dBc/Hz at the higher frequency offsets. Rotation of the constellation states and increased dispersion can be a result of the increased phase noise, and EVM increases to 4.07%. The EVM normalization reference is set to reference root mean square (RMS) for these EVM measurements.

Removing undesired image products, LO feedthrough, out-of-band spurious products and emissions, and other undesired spectral artifacts of nonlinear mixing often requires filters. Filters, as well as other components in the test system such as mixers and amplifiers, can introduce linear amplitude and phase error over extreme signal bandwidths. An adaptive equalizer helps to mitigate the linear amplitude and phase errors, similar to what might be implemented in a receiver. Typically, a receiver system needs some baseband equalization because the signals it receives are never ideal, including channel impairments. In a wide or extreme bandwidth test system, the test equipment receiver (for example, IF digitizer) can use adaptive equalization to remove linear amplitude and phase impairments across the extreme signal bandwidth. However, the adaptive equalizer will operate only on the linear amplitude and phase error. Noise and nonlinear impairments will remain and will impact EVM, whether the equalizer is enabled or not. The adaptive equalizer cannot remove nonlinear impairments from any compressed amplifiers in the test system signal path or LO phase noise. It may impact the mmWave test system’s residual EVM.

To illustrate this, a bandpass filter centered at 144 GHz and a power amplifier (PA) are added to the upconverter design. The amplifier has gain and an output 1 dB compression point specified. An output third-order intercept (TOI) point is specified for the mixer to model nonlinear characteristics.

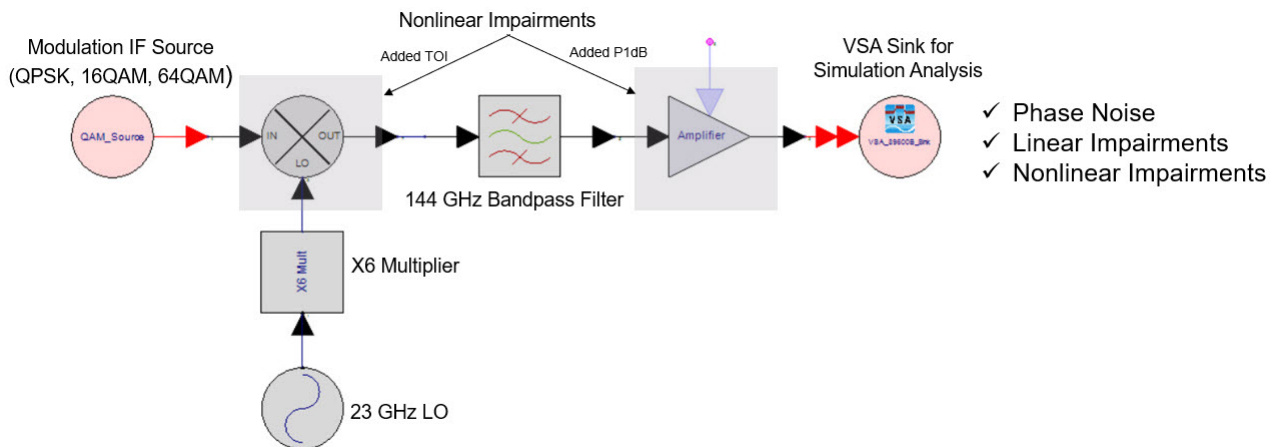

Figure 4. Bandpass filter and power amplifier added to sub-terahertz upconverter design

The simulation results on the left in Figure 5 show the EVM without the adaptive equalizer enabled. The EVM is 15.99%, and the associated dispersion is seen in the constellation states. It is difficult to determine, however, if linear amplitude and phase error from the bandpass filter or nonlinear distortion from the PA or mixer causes the dispersion.

- ✓ Phase Noise
- ✓ Linear Impairments
- ✓ Nonlinear Impairments

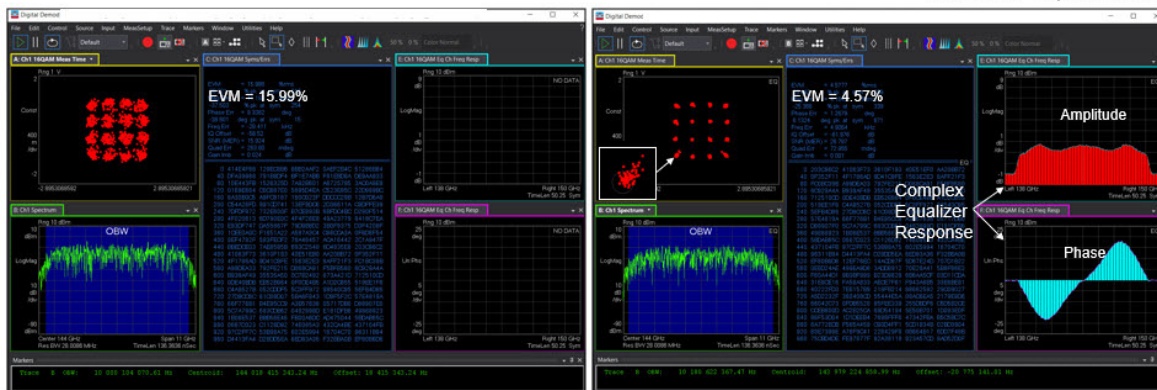

Figure 5. Simulation results with bandpass filter and power amplifier added

To gain more insight into the error contributors, the simulation results on the right show the EVM with the adaptive equalizer enabled. EVM is better than it is without equalization, but it has increased to 4.57% compared to the scenario without the bandpass filter and PA because of the nonlinear impairments from the mixer and the PA. The adaptive equalizer cannot correct for nonlinear impairments, so it is removing only the linear amplitude and phase errors from the bandpass filter. Nonlinear impairments remain and have increased the EVM result. After the adaptive equalizer has run, a diagonal pattern in the constellation states appears. This pattern is a result of the gain compression that is now present on the signal. It illustrates how the adaptive equalizer corrects for linear impairments but not nonlinear impairments.

If a system engineer wanted to see the mixer’s contribution versus the PA, it is simple to evaluate in simulation. The system engineer could deactivate, or short-circuit, the PA and resimulate or alter the mixer or PA to remove the P1dB or TOI (simulate with ideal components). This is the benefit of simulation — it is convenient to look at “what-if” scenarios to gauge how the system performance might vary under different scenarios.

These simulations used single-carrier QAM waveforms, but it would be possible to model and simulate other waveforms to assess their performance through the sub-terahertz upconverter design. Waveform definition is not finalized until the physical-layer standards are defined. A sub-terahertz test system therefore needs to provide flexibility to test and demonstrate a number of proposed candidate waveforms that may be custom or proprietary in nature. Moving toward a 1 Tb/s data rate ^[2] requires rethinking traditional waveforms such as single-carrier QAM or orthogonal frequency-division multiplexing. System design simulation will play a role in evaluating predicted system performance under a variety of simulated scenarios. Ideally, the test system can leverage the same waveforms used for system simulation for a continuous design-to-test flow.

The sub-terahertz research and development (R&D) testbed presented in this white paper takes into account these design and test challenges. It will be applied at D-band with up to 10 GHz of channel bandwidth.

A New Sub-Terahertz Testbed for 6G Research

Keysight's new extreme-bandwidth R&D sub-terahertz testbed shown in Figure 6 addresses the bandwidth and performance demands for 6G research.

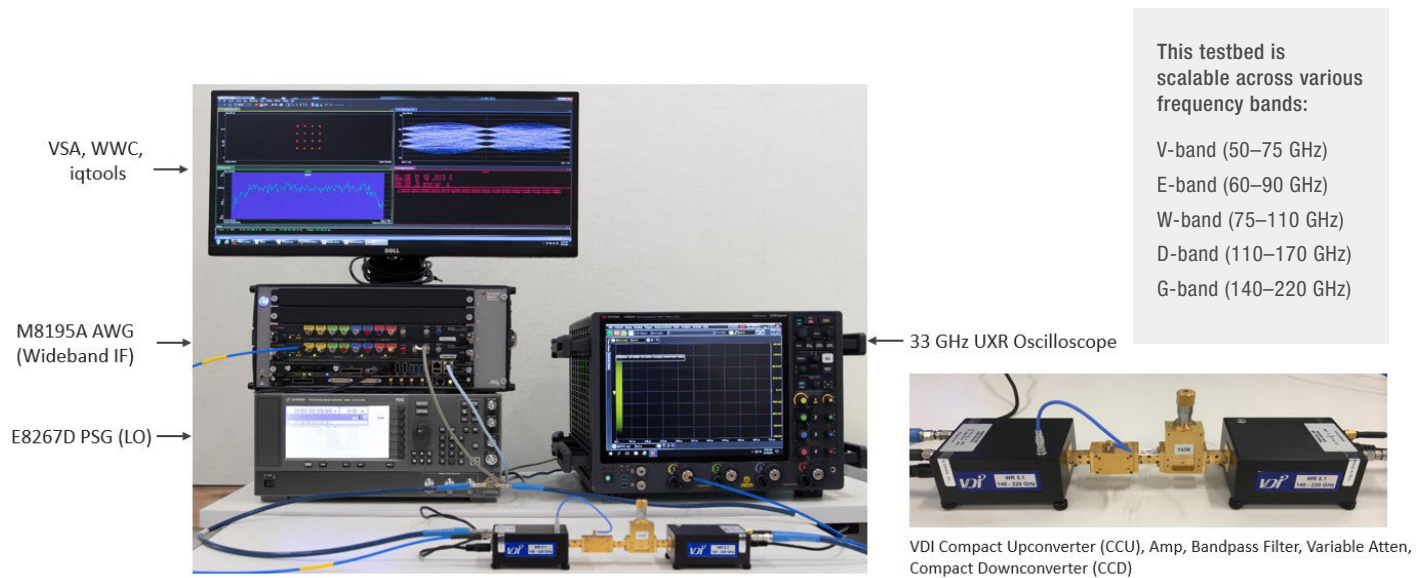

Figure 6. Sub-terahertz R&D testbed, conducted measurements

A multichannel Keysight M8195A 65 GSa/s arbitrary waveform generator (AWG) generates wideband and extreme-bandwidth modulated IF signals. The M8195A has an analog bandwidth of 25 GHz. An IF of 4–6 GHz is useful to provide a frequency that is high enough to allow for filtering the undesired image product after upconversion to the sub-terahertz frequency band, but low enough to achieve optimal EVM performance because of the oversampling processing gain with the M8195A's sampling rate.

Virginia Diodes Inc. (VDI) compact D- or G-band upconverters convert the 4–6 GHz IF (dependent on modulation bandwidth) from the M8195A to the desired sub-terahertz frequency band. These compact VDI upconverters use a 6x multiplication factor for the LO frequency. A 67 GHz Keysight E8267D PSG vector signal generator with optional UNY provides a low-phase-noise LO for the VDI upconverter.

On the receive side, the signal is downconverted with the compact VDI downconverter to a 4–6 GHz IF and digitized with a UXR multichannel high-performance oscilloscope or a Keysight M8131A multichannel AXIe streaming digitizer. Figure 6 shows a 33 GHz 128 GSa/s 10-bit UXR.

This testbed is scalable across various frequency bands (V, E, W, D, and G) by using different VDI converters. It is also flexible in terms of waveforms by using a variety of software platforms to generate and analyze candidate waveforms. The testbed supports software written for test applications, as well as PathWave SystemVue design software, VSA software, or IQtools (MATLAB-based). The testbed hardware is also multichannel, so the number of channels is scalable for MIMO research.

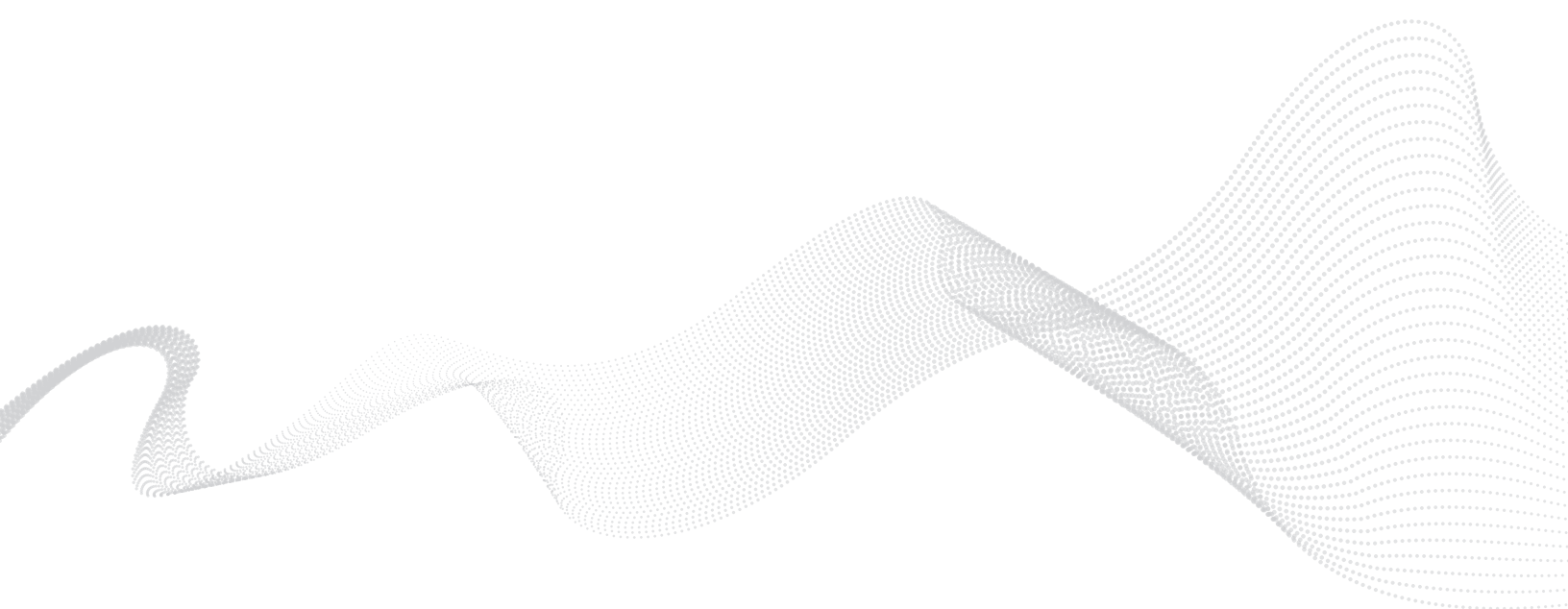

Conducted Sub-Terahertz Wide-Bandwidth Measurement Results

Single-carrier QAM measurements were performed at D-band in the 140 - 148 GHz frequency band (centered at 144 GHz) with varying modulation bandwidths. These were conducted measurements (waveguide-to-waveguide), without horn antennas. A VDI D-band amplifier, VDI 140 - 148 GHz bandpass filter, and variable attenuator were connected between the VDI upconverter and VDI downconverter, along with waveguide test ports (waveguide through sections).

Since 6G waveforms are not defined, preliminary 802.11ay test software was used for the signal generation and analysis as an initial test case and as an example of an emerging wideband standard with optional bandwidths up to 8.64 GHz. Figure 7 shows measurements for an 802.11ay two-channel bonded (CB2) signal centered at 144 GHz with 4.32 GHz channel bandwidth.

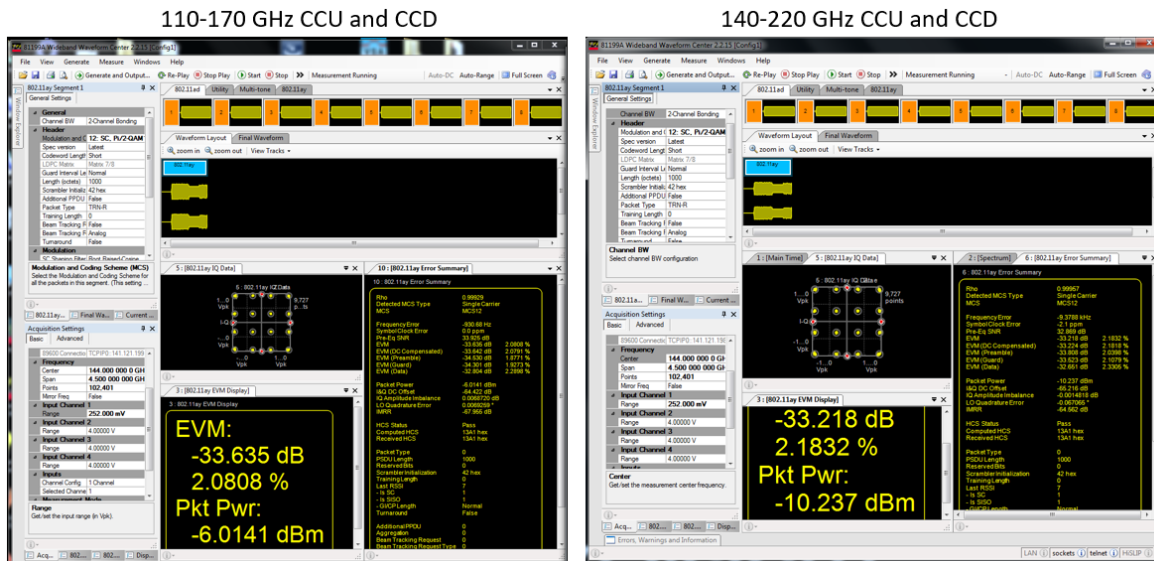

Figure 7. 16 QAM MCS12 measurements performed at 144 GHz with D-band (left) and G-band (right) VDI converters, CB2 configuration with 4.32 GHz channel bandwidth

Software was used to generate the 802.11ay two-channel bonded (CB2) 4 GHz IF signal with the M8195A AWG. This signal was then upconverted to 144 GHz with the VDI upconverter. After the signal was downconverted from 144 GHz back to a 4 GHz IF with the VDI downconverter, the UXR oscilloscope digitized it and the software demodulated it. These measurements used a 16 QAM MCS12 signal, but higher-order 64 QAM MCS20 signals have performed similarly. No calibration was performed for these measurements.

The same test setup was used to perform measurements for an 802.11ay four-channel bonded (CB4) signal centered at 144 GHz with 8.64 GHz channel bandwidth. The CB4 test case used a higher-frequency 5 GHz IF to make filtering of the undesired image easier. The measurement results appear in Figure 8.

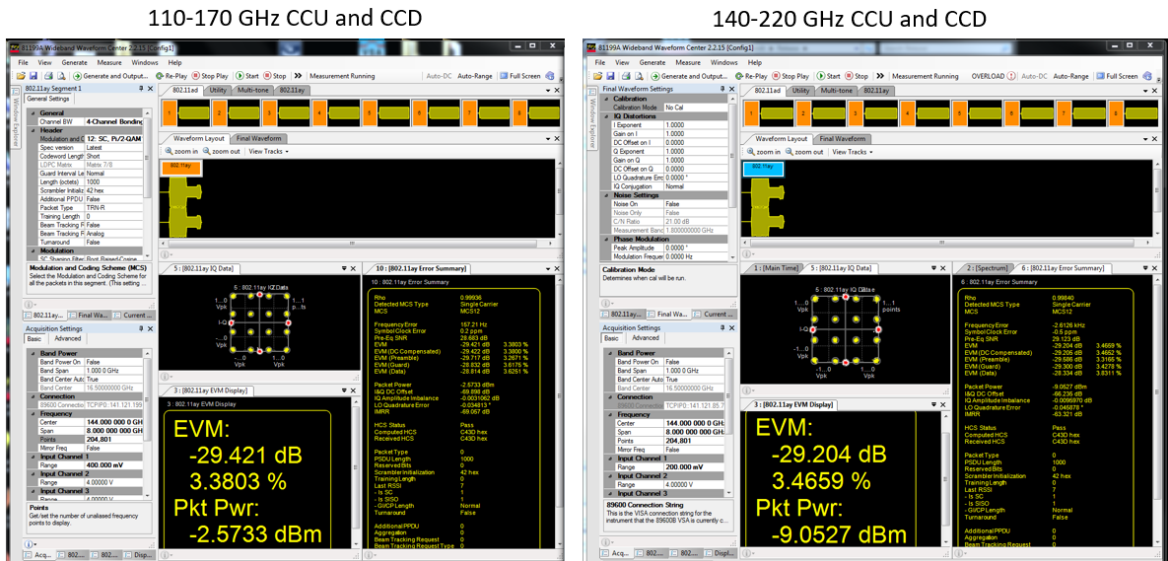

Figure 8. 16 QAM MCS12 measurements performed at 144 GHz with D-band (left) and G-band (right) VDI converters, CB4 configuration with 8.64 GHz channel bandwidth

As expected, there was EVM degradation because the modulation bandwidth doubles from Figure 7 to Figure 8, thus increasing the integrated noise power within the signal bandwidth. In addition, there is greater linear amplitude and phase variation as the signal bandwidth increases. No calibration was performed for these measurements.

Conducted Sub-Terahertz Extreme-Bandwidth Measurement Results

The same test setup used for the measurements shown in Figures 7 and 8 was used to perform measurements at 144 GHz for an extreme-bandwidth test case with an occupied bandwidth of 10 GHz. These were performed with the VDI G-band (140–220 GHz) converters. The IF increased to 6 GHz, once again to make filtering of the undesired image easier given the wider modulation bandwidth.

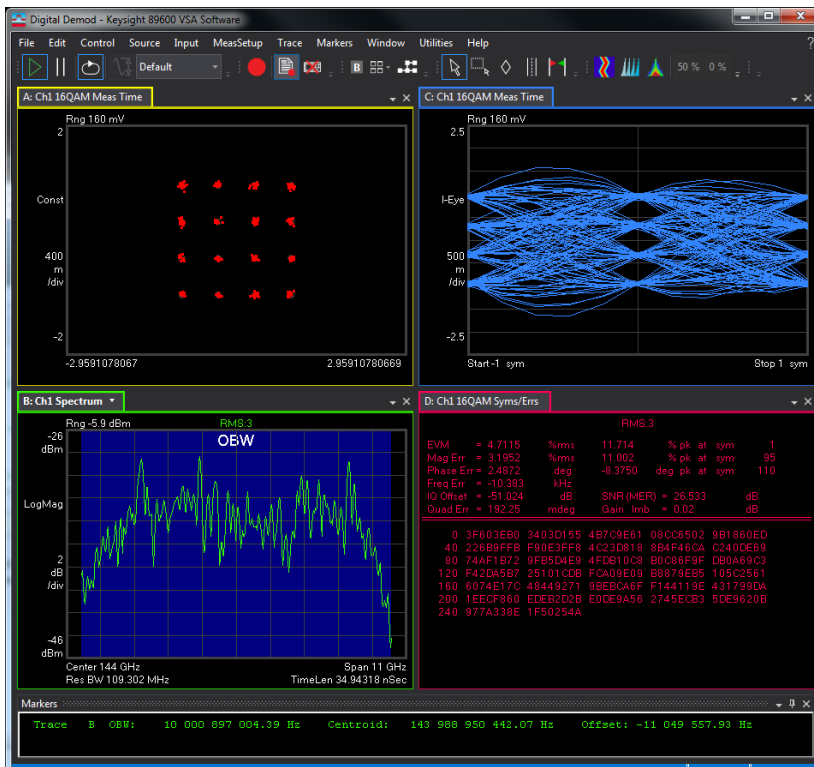

Figure 9. 16 QAM measurements performed at 144 GHz with G-band VDI converters, 10 GHz occupied bandwidth

The baseband waveform was pre-corrected with a complex response before downloading the waveform to the M8195A AWG. The VSA adaptive equalizer was disabled for these measurements after pre-correcting the waveform, and the measured EVM was 4.7%. The EVM normalization reference was set to reference RMS for these EVM measurements.

The modulation order then increased to 128 QAM, as shown in Figure 10.

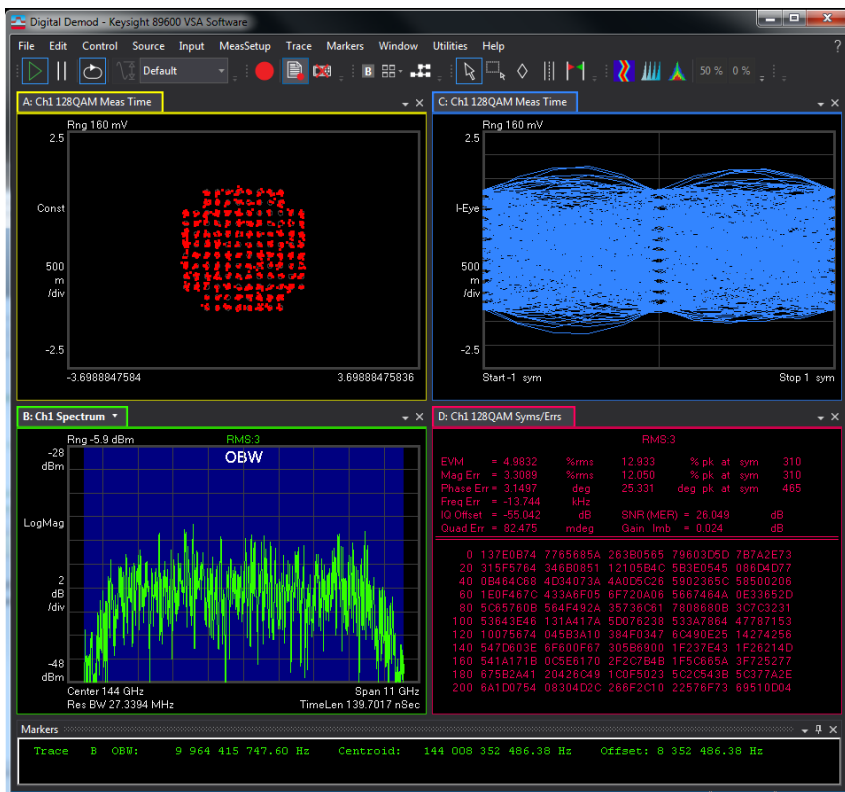

Figure 10. 128 QAM measurements performed at 144 GHz with G-band VDI converters, 10 GHz occupied bandwidth

The symbol rate was 8.8 GHz, so the theoretical raw calculated data rate without forward error correction (FEC) coding rate redundancy would be 8.8 Gsymbols/sec * 7 bits/symbol = 61.6 Gb/s for a single stream of data.

Over-the-Air Sub-Terahertz Testbed Measurements

For the over-the-air (OTA) measurements, an M8131A digitized the IF from the VDI downconverter. The M8131A digitizer offers a compact AXle form factor, enabling it and the M8195A AWG to work together in one AXle five-slot chassis. Figure 11 shows a picture of the sub-terahertz testbed with the M8131A digitizer.



Figure 11. 16 QAM OTA measurements performed at 144 GHz with G-band VDI converters, 10 GHz occupied bandwidth

The M8131A streaming digitizer has an analog bandwidth of up to 12.5 GHz with 10 bits of vertical resolution at a maximum sample rate of 32 GSa/s with up to two channels. Testing occurred OTA in an anechoic chamber using VDI G-band converters and rectangular horn antennas spaced approximately 35 cm, or 14 inches, apart.

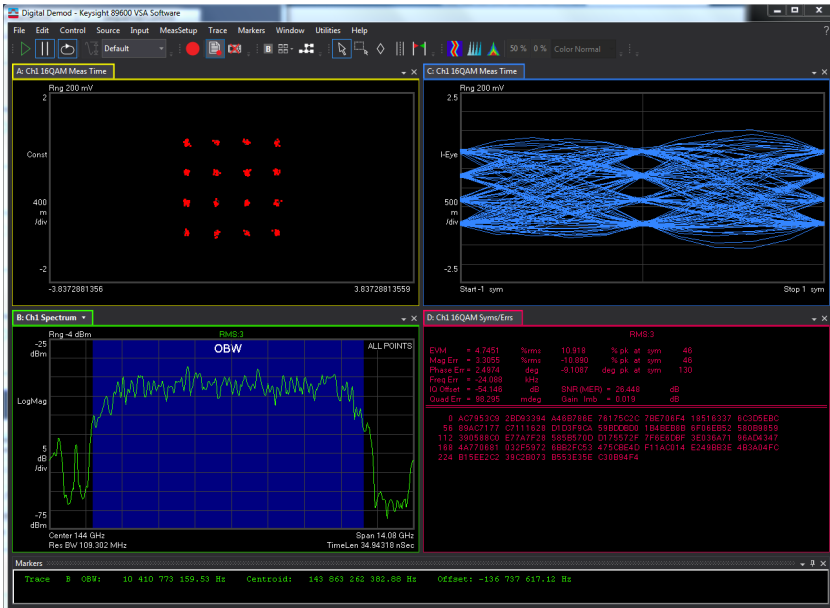

Figure 12. 16 QAM OTA measurements performed at 144 GHz with G-band VDI converters, 10 GHz occupied bandwidth

For the OTA test case, the baseband waveform for the M8195A AWG was pre-corrected with a complex response to help correct for the channel and signal path before downloading the waveform to the AWG. The VSA adaptive equalizer was also enabled for the signal measured using the M8131A digitizer to help compensate for the OTA channel impairments. The measured OTA EVM is 4.75% compared with the 4.71% EVM shown for the conducted case in Figure 9. The EVM normalization reference is set to reference RMS for these EVM measurements.

Summary

This white paper presents a new R&D sub-terahertz testbed for 6G research and discusses key considerations to optimize system performance for extreme bandwidths. The R&D testbed offers flexibility and scalability in prototyping various types of waveforms and operating in different frequency bands. It is also scalable for multiple channels for MIMO research.

The white paper demonstrates measurement results in the 140–148 GHz frequency band using both D-band (110–170 GHz) and G-band (140–220 GHz) VDI converters. It shows conducted single-carrier 16 QAM measurements for 802.11ay CB2 (4.32 GHz channel bandwidth) and CB4 (8.64 GHz channel bandwidth) centered at 144 GHz. It also shows an extreme bandwidth test case with 10 GHz of occupied bandwidth centered at 144 GHz. This corresponds to a theoretical raw calculated data rate of 61.6 Gb/s for a single stream of data without FEC coding rate redundancy.

Acknowledgments

Keysight Technologies would like to acknowledge Samsung Research for their collaboration on the work shown in this white paper.

Keysight Technologies would like to acknowledge Virginia Diodes Inc. (VDI) for providing the VDI D- and G-band hardware shown in this white paper.

References

- [1] Tariq, Faisal, Muhammad R. A. Khandaker, Kai-Kit Wong, Muhammad Imran, Mehdi Bennis, and M'rouane Debbah. "A Speculative Study on 6G." IEEE Magazine, 2019. <https://arxiv.org/pdf/1902.06700.pdf>.
- [2] Key Drivers and Research Challenges for 6G Ubiquitous Wireless Intelligence. Oulu, Finland: University of Oulu, 2019. <https://jultika.oulu.fi/files/isbn9789526223544.pdf>.
- [3] Li, Richard, et al. Network 2030: A Blueprint of Technology, Applications, and Market Drivers Towards the Year 2030 and Beyond. FG-NET-2030, 2019. https://www.itu.int/en/ITU-T/focusgroups/net2030/Documents/White_Paper.pdf.
- [4] "Spectrum Horizon," ET Docket No. 18-21, RM-11795, FCC 19-19, March 15, 2019.
- [5] Millimeter Wave Propagation: Spectrum Management Implications. Washington, DC: Federal Communications Commission, Office of Engineering and Technology, Bulletin Number 70, 1997. https://transition.fcc.gov/Bureaus/Engineering_Technology/Documents/bulletins/oet70/oet70a.pdf
- [6] Xing, Yunchou, and Theodore S. Rappaport. "Propagation Measurement System and Approach at 140 GHz-Moving to 6G and Above 100 GHz." Paper presented at 2018 IEEE Global Communications Conference (GLOBECOM), Abu Dhabi, United Arab Emirates, December 2018.

Learn more at: www.keysight.com

For more information on Keysight Technologies' products, applications or services, please contact your local Keysight office. The complete list is available at: www.keysight.com/find/contactus

